

Bobtot



Quick Setup Guide

B38

5.1 CHANNEL HOME THEATER SYSTEM

Table of Contents

What's In the Box.....	3
Important Safety Instructions.....	3
Best Placement for 5.1 Home Theater System.....	4
Mounting Instructions.....	5
Set Up Center & Front & Rear Speakers.....	6
Front Panel of Subwoofer.....	7
Back Panel of Subwoofer.....	8
Remote Control Function.....	9
Composite Connection(Getting Started).....	10
-Connect a device by wireless BT.....	10
-Connect a device with a TV ARC cable.....	11
-Connect a device with Optical cable.....	11
-Connect a device with Coaxial cable.....	11
-Connect a device with 2RCA M/M Stereo Audio cable.....	12
-Connect a device with 3.5mm to 2-Male RCA Audio Stereo cable....	12
-Connect a device with 3RCA Video Audio cable.....	12
-Connect with Antenna for FM radio.....	13
-Playing with USB/SD.....	13
Product Specifications.....	14
Need Help.....	14
Certification.....	15

Introduction

Thank you for purchasing the Bobtot 5.1 Channel Home Theater System . We encourage you to read this instruction guide before using and retain this for future reference. Also, please inspect the package contents and ensure there are no missing or damaged parts.

What's In the Box

- 1) Subwoofer with Built-In Receiver
- 2) Center Channel Speaker
- 3) 2 * Front Channel Speakers
- 4) 2 * Rear Channel Speakers
- 5) 3 * RCA Video Audio Cable
- 6) 1 * Full Function Remote
- 7) TV ARC Cable
- 8) Optical Stereo Cable
- 9) Coaxial Cable
- 10) 3.5mm to 2-Male RCA Audio Stereo Cable
- 11) FM Antenna Cable
- 12) Quick Setup Guide

IMPORTANT SAFETY INSTRUCTIONS



TO REDUCE THE RISK OF ELECTRICAL SHOCK, DO NOT REMOVE AMPLIFIER PLATE. NO USER SERVICEABLE PARTS INSIDE. WE RECOMMEND TAKING THE UNIT TO A QUALIFIED SERVICE TECHNICIAN FOR ANY REPAIRS.

Read the following safety instructions before operating your home theater system.

- Do not place these speakers on an unstable surface. The speaker may fall over, causing serious injury to a child or adult and serious damage to the unit.
- Do not use these speakers near water or expose them to rain or moisture.
- The speakers should be situated away from heat sources such as radiators, heat registers, stoves, or other devices that produce heat.
- Please use under specified voltage(120V/60Hz). Any other voltage than the specified voltage may cause fire or electric shock.
- To reduce the risk of electric shock or component damage, unplugged the power before moving your speakers or connecting other components to your device.
- Clean only with a soft dry cloth. Unplug the main unit from the wall outlet before cleaning.

CAUTION: Always use a power outlet that is properly grounded.

BEST PLACEMENT FOR 5.1 Home Theater System

1. Most people place the subwoofer in the front of the room, near the sound input source, for ease of connection. But since bass frequencies are omnidirectional the subwoofer can be placed anywhere. Try placing it near a wall or a corner for increased bass.
2. The center channel speaker should be placed directly in front of the listening position, above or below the sound input source. If possible, tilt it as necessary to direct the sound to ear level.
3. Mount the front speakers on the wall, directly to the left and right of the center channel speaker. Angle them towards the listening position. Preferably, the tweeters should be at ear level.
4. Mount the satellite speakers on the wall, slightly behind the listening position, about 1 to 2 feet above ear level. If side placement isn't possible place them to the rear of the listening position and angle them forward.

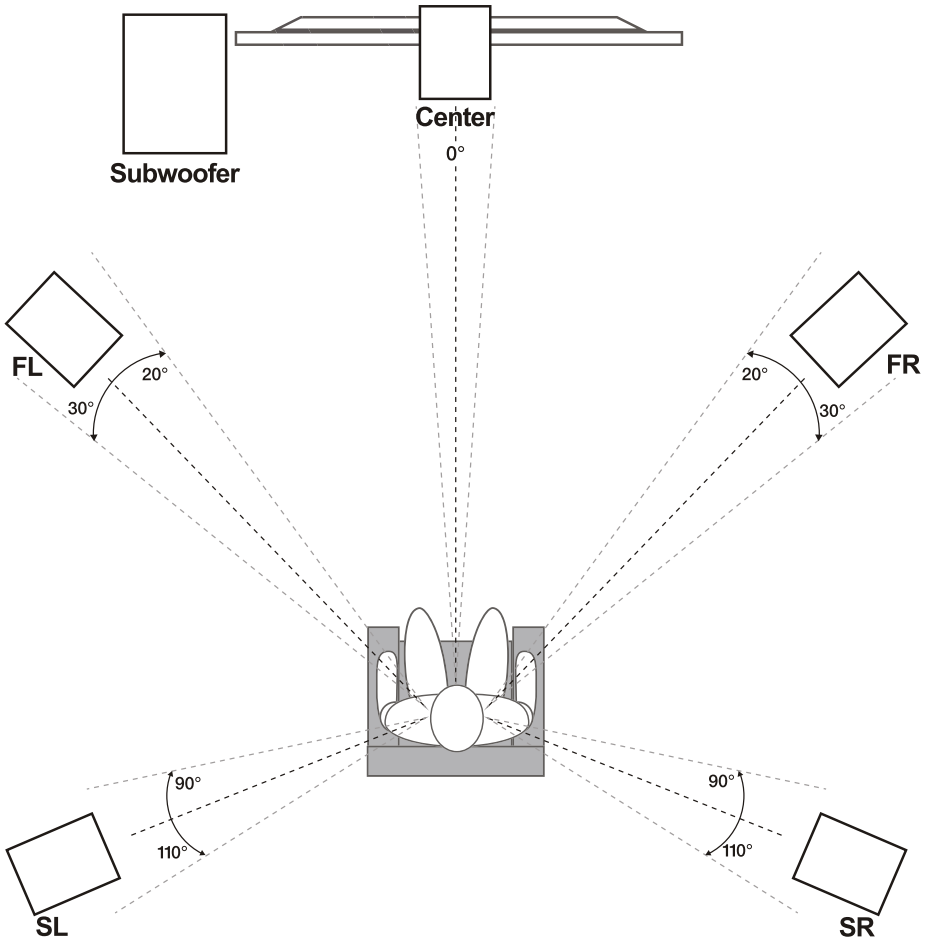

MOUNTING INSTRUCTIONS

Before you begin please make sure you have the proper tools and necessary accessories. For this installation you will need the following items:

- mounting brackets and screws (included)
- wall hooks (optical, not included)
- speaker cable (built-in, included)
- drill (not included)
- phillips screw driver (not included)

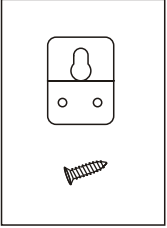

Make sure you have all the necessary screws and brackets. There should be five brackets and one bag of screws. If any of these items are missing, please contact Bobtot.

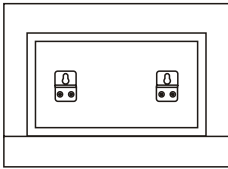
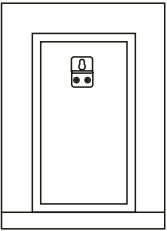

Using two screws, secure one bracket to the back of each speaker you wish to mount. If you are mounting the speakers horizontally, you will need to use two brackets for each speaker.

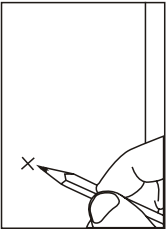

Now mark on the wall the place where you will be mounting your speakers. Use the diagram from the **POSITIONING THE SPEAKERS** section to determine the best location. Both front speakers should be at the same height; the same goes for the satellite units. Remember to keep speakers at least two feet away from corners, and make sure you have enough wire to reach the mounting location.

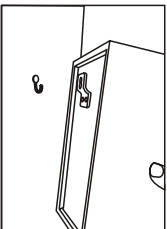

You can use a screw or a mounting hook to hang the speaker. Use a screw with a drywall insert or drive it into a wall stud to ensure that it is securely fastened to the wall. Use a stud finder to locate the stud and to make sure that there are no wires or cable lines located in that area. Once the mounting hooks or screws are in place, you are ready to begin mounting. Be sure to wire each speaker before mounting it to the wall.

SET UP CENTER & FRONT & REAR SPEAKERS

Place speakers in the ideal position, using the built-in electric cable to connect the center & front & rear satellite speakers to the “CEN & FL & FR & SL & SR” of the Audio Output RCA socket on the subwoofer unit.

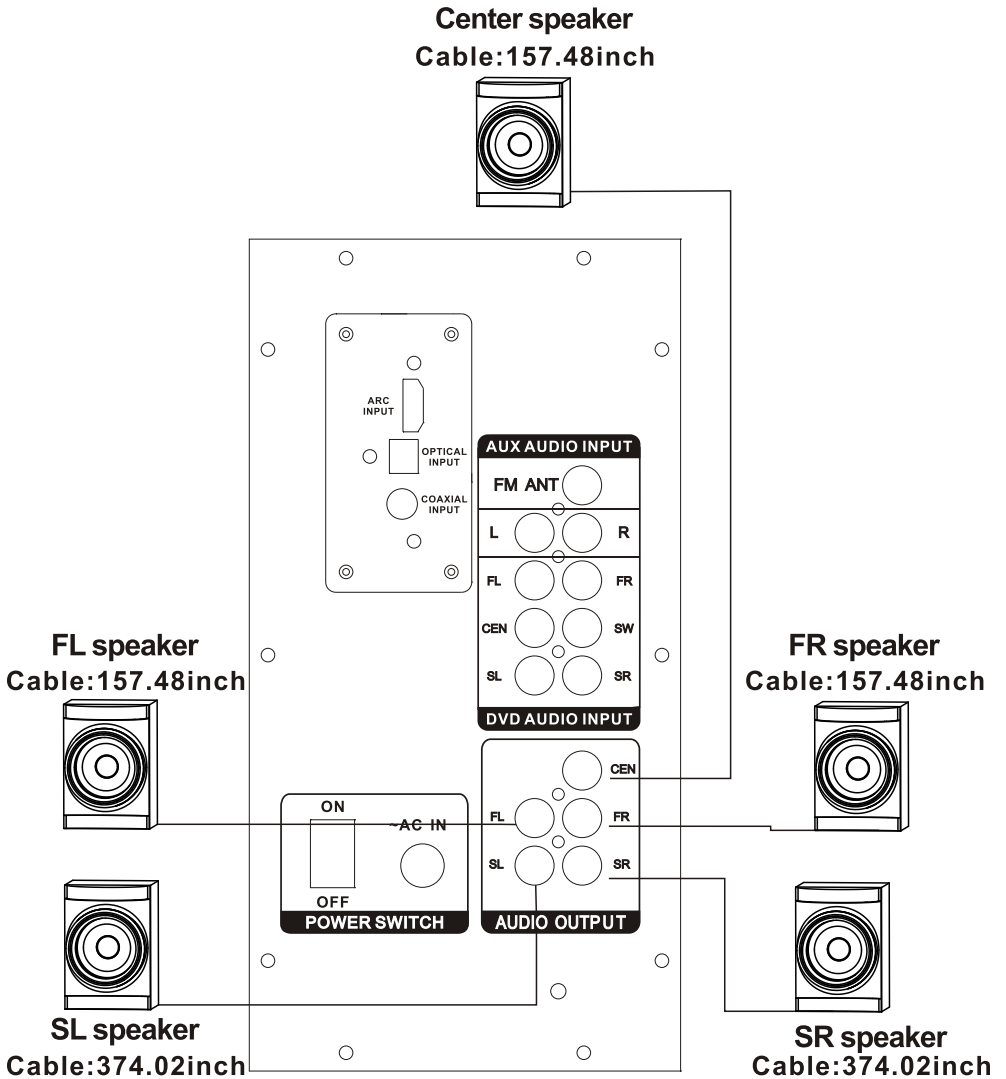

FRONT PANEL OF SUBWOOFER

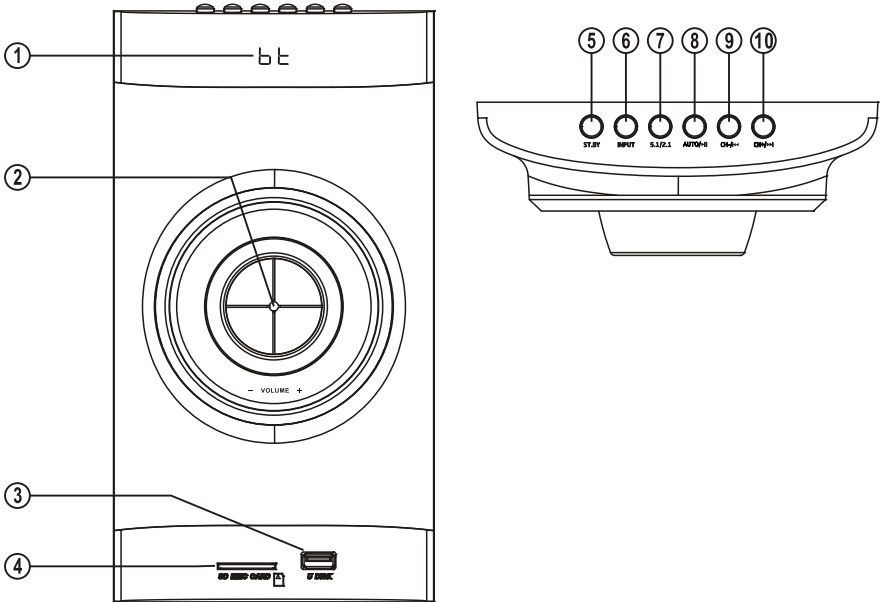

- ① Digital Display
- ② VOLUME-----Turn the knob to decrease or increase the volume
- ③ U DISK-----USB socket (max file size 64Gb)
- ④ SD/MMC CARD-----SD card socket (max file size 64 Gb)
- ⑤ ST.BY ----- Stand by function by pressing it 3 secs in
AUX/USB/FM/BT/OPTICAL/COAXIAL
/TV ARC mode.
- ⑥ INPUT ----- Input function key, switch among AUX
/USB/DVD/FM/BT/OPTICAL/ COAXIAL
/TV ARC mode.
- ⑦ 5.1/2.1-----5.1/2.1 function key.
- ⑧ AUTO/ || -----USB Pause/Play function key.
When the FM state when the automatic
search and save the radio station.
- ⑨ CH-/I<<----- "Previous" function key.
Previous song when USB/SD input;
Previous channel when FM input;
- ⑩ CH+/>>-----"Next" function key.
Next song when USB/SD input;
Next channel when FM input;

BACK PANEL OF SUBWOOFER

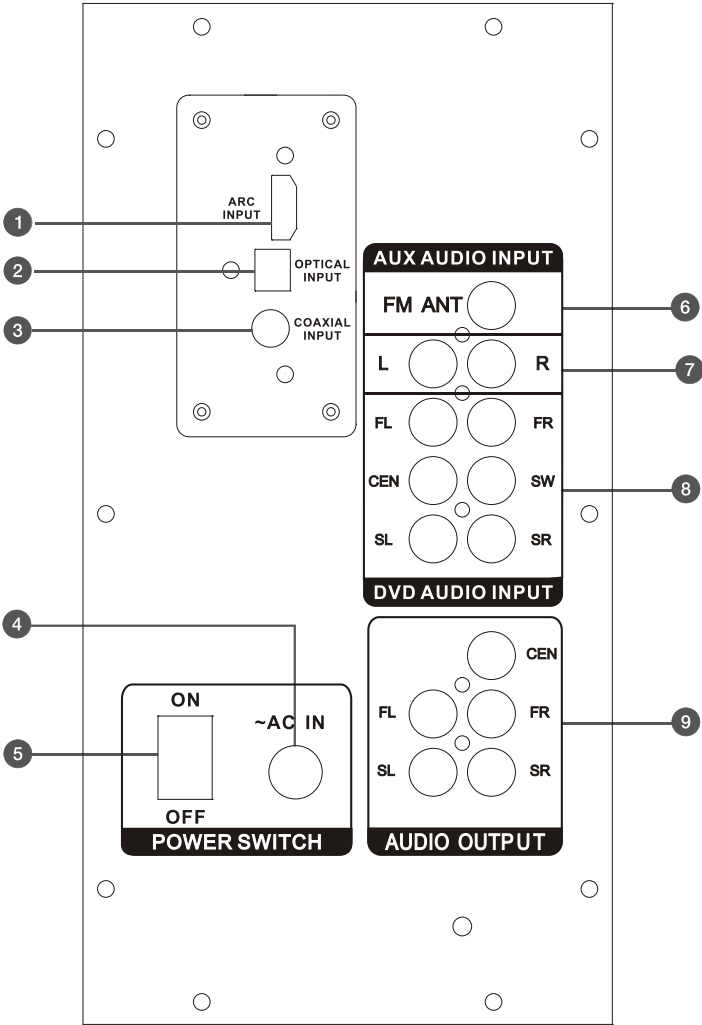

1. TV ARC audio input
2. Optical audio input
3. Coaxial audio input
4. Power input
5. Power switch
6. FM antenna
7. RCA to RCA or RCA to 3.5mm AUX audio input
8. 3PCS RCA DVD audio input (front L&R/center/subwoofer/rear L&R)
9. Center/Front L/R/Rear L/R audio output

REMOTE CONTROL FUNCTIONS

 : Power/Standby

INPUT: Switch between input modes:USB/SD/FM/
AUX/DVD/OPT/COA/TV ARC/BT

MUTE: Mute all output

5.1/2.1: Channel mode select

SLEEP-/+: Setting the sleep time

SAVE: Save stations to unit memory

TUNE+/-: Manually tune FM stations

: Play/Pause in USB/SD/BT modes

AUTO: Automatic station search

CH-/<<<:Previous FM station/previous track(USB/SD)

CH+/>>>:Next FM station/next track(USB/SD)

FL+/-: Front left speaker volume control

FR+/-: Front right speaker volume control

SW+/-: Subwoofer volume control

CEN+/-: Center speaker volume control

VOL+/-: Master volume control

SL+/-: Rear satellite left speaker volume control

SR+/-: Rear satellite right speaker volume control

0-9: Number pad used to direct select tracks when
in USB/SD mode

REPEAT: Repeat one song/repeat all songs/shuffle

RESET: Reset volume level

EQ+/-:In USB/SD mode they will allow you to navigate
the 5 preset EQ curves.

DISP+/-:They will control the display brightness.

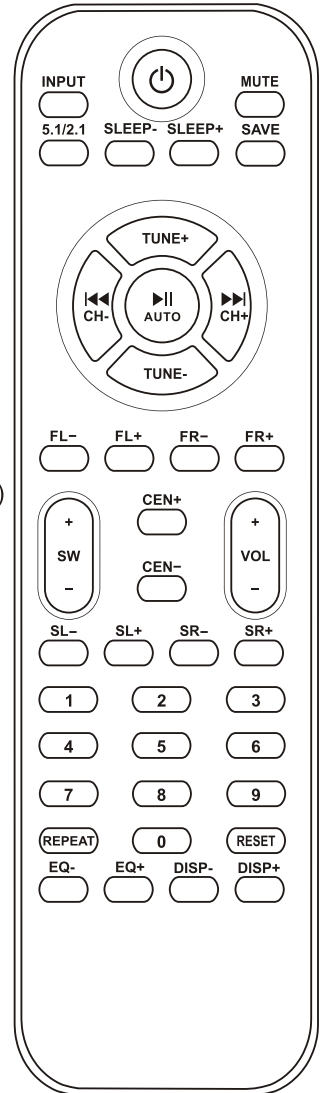

COMPONENT CONNECTIONS

Verify that your device can be used to input sound from audio/video for other external sound source devices, and ensure your device have an available jack to match the appropriate port on the subwoofer, e.g: TV ARC, Optical, Coaxial, RCAs...

B38 Home theater system is suitable for many TVs, projector, digital set-top boxes, game consoles, DVD players, Blu-ray players, CD players, etc.

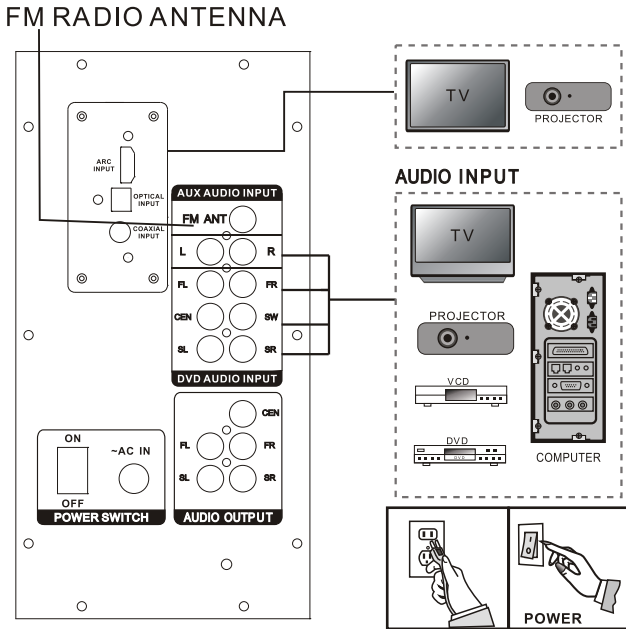

Connecting a device by wireless BT

1. Make sure the wired center speaker and FL & FR, SL & SR speaker have plugged into the match Audio Output Socket of the subwoofer, and the power is "ON" status.
2. Press "INPUT" button by remote or in the subwoofer, switch mode to "BT" showing in the LED display of the subwoofer.
3. On your smartphone or tablet or other wireless BT device, search for the BT named " **Bobtot B38** " and tap to connect. Now you can enjoy the music.

Note: If your device requires the password, please enter " 0000 " .

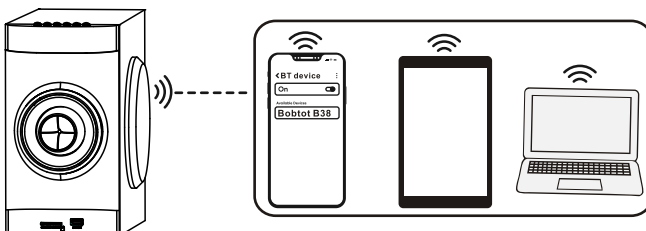

Connecting a device with a TV ARC cable

1. Verify that your device has ARC/eARC output.
2. Connect the TV ARC cable to the subwoofer and your device.
3. Make sure the units are plugged in and power "**ON**" status.
4. Press the "**INPUT**" button by remote or in the subwoofer, switch mode into "**ARC**" which is showing in the LED display of the subwoofer.
5. Some TVs could automatically recognize the audio output as ARC audio output after connecting ARC cable, you can enjoy it now. If your device couldn't, please manually enter into the audio sound out setting to choose "ARC Audio Output."

NOTE: B38 ARC output only supports LPCM 2.0 audio format.



Connecting a device with Optical cable

1. Verify that your device has an "**Optical**" output.
2. Connect the optical cable to your device and subwoofer.
3. Make sure the units are plugged in and power "**ON**" status.
4. Press the "**INPUT**" button by remote or in the subwoofer, switch mode into "**OPT**" which is showing in the LED display of the subwoofer.
5. Choose "**PCM**" not "Automatic" from the Digital output audio format of the audio setting of your device. You can enjoy it now.

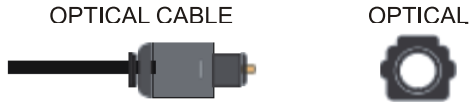

Connecting a device with Coaxial cable

1. Verify that your device has an "**Coaxial**" output.
2. Connect the coaxial cable to your device and subwoofer.
3. Make sure the units are plugged in and power "**ON**" status.
4. Press the "**INPUT**" button by remote or in the subwoofer, switch mode into "**COA**" which is showing in the LED display of the subwoofer.
5. Choose "**PCM**" not "Automatic" from the Digital output audio format of the audio setting of your device. You can enjoy it now.

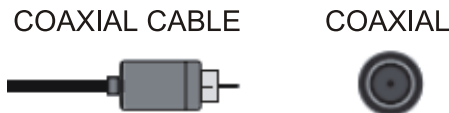

Connecting a device with 2RCA M/M Stereo Audio cable

1. Verify that your device has RCA L/R output.
 2. Connect the RCA L/R cable to your device and subwoofer.
 3. Make sure the units are plugged in and power "ON" status.
 4. Press the " **INPUT** " button by remote or in the subwoofer, switch mode into " **AU** " which is showing in the LED display of the subwoofer.
- Now you can enjoy it.

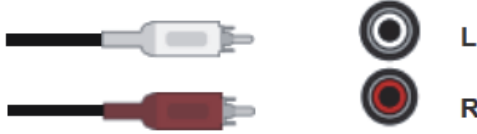

Connecting a device with 3.5mm to 2-Male RCA Audio Stereo cable

1. Verify that your device have a 3.5mm AUX jack output.
 2. Connect the RCA L/R cable to the subwoofer and 3.5mm AUX plug into your device.
 3. Make sure the units are plugged in and power "ON" status.
 4. Press the " **INPUT** " button by remote or in the subwoofer, switch mode into " **AUX** " which is showing in the LED display of the subwoofer.
- Now you can enjoy it.

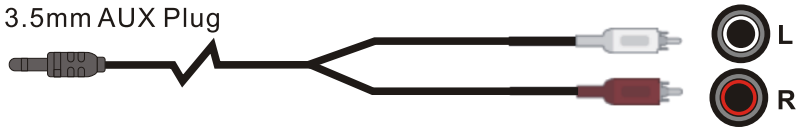

Connecting a device with 3RCA Video Audio cable

1. Verify that your device have 3RCA output.
 2. Connect the 3RCA cables to your device and subwoofer.
 3. Make sure the units are plugged in and power "ON" status.
 4. Press the " **INPUT** " button by remote or in the subwoofer, switch mode into " **DV** " which is showing in the LED display of the subwoofer.
- Now you can enjoy it.



Connecting by Antenna for FM radio

1. Put the white Antenna cable plug into "**FM ANT**" jack on the back of subwoofer.
2. Make sure the units are plugged in and power "**ON**" status.
3. Press the "**INPUT**" button by remote or in the subwoofer, switch mode into "**FM**" which is showing in the LED display of the subwoofer.
4. Long press the "**AUTO**" button about 3 seconds, it will be automatically searching for radio stations.
5. Manually save stations:
 - press the "**TUNE+/TUNE-**" button to search for a station you like.
 - press the "**SAVE**" button, it will display some radio channel on the screen, press the "**CH-/CH+**" buttons to choose the broadcast channel you like.
 - press the "**SAVE**" button again, it will save the radio channel & the message "good" will be displayed.
6. Press the "**CH-/CH+**" button to search through saved stations or press the "**TUNE+/TUNE-**" buttons to manually find a station what you like.

Playing USB

1. Make sure the units are plugged in and power "**ON**" status.
2. Plug your USB drive into USB jack of the subwoofer.
3. Press the "**INPUT**" button by remote or in the subwoofer, switch mode into "**USB**" which is showing in the LED display of the subwoofer.
Now you can enjoy the music.

Playing SD

1. Make sure the units are plugged in and power "**ON**" status.
2. Plug your SD drive into SD jack of the subwoofer.
3. Press the "**INPUT**" button by remote or in the subwoofer, switch mode into "**SD**" which is showing in the LED display of the subwoofer.
Now you can enjoy the music.

Product Specifications

- 5.1 Channel Home Theater System
- 400 Watts Peak Power
- 200 Watts Program Power
- 100 Watts Continuous RMS Power
- BT Version: 5.0+EDR
- Input Voltage: AC 120V/60Hz
- System Impedance: 4": 4Ohm /2.75" driver: 4 Ohm
- Frequency Response: 40Hz - 18KHz
- Amplifier: Class AB, very efficient amplifier with top components
- Signal to Noise Ratio: ≥ 70 dB (Maximum output with THD+1<1%)
- Cable Length(Built-in): Front L/R Speaker: 157.48inch;
Center Speaker: 157.48inch;
Rear L/R Speaker: 374.02inch.
- Subwoofer Size: (W*D*H) 5.51" x 12.32" x 10.15"
- Center Satellite Speaker Size: (W*D*H) 3.54" x 3.74" x 5.11"
- Front L/R Satellite Speaker Size: (W*D*H) 3.54" x 3.74" x 5.11"
- Rear L/R Satellite Speaker Size: (W*D*H) 3.54" x 3.74" x 5.11"

Need Help ?

Customer Care Guide

At our company, we strive to provide exceptional customer care to every one of our clients. We believe that building strong relationships with our customers is essential to the success of our business. To help us achieve this goal, we have put together the following customer care guide.

Time

We understand that our customers' time is valuable, so we will respond to any inquiries within 24 hours.

Feedback

We know that our customers are the heart of our business so we value your feedback. We encourage you to share your thoughts and ideas with us.

Solutions

If our customers encounter any issues, we will try our best to find a quick and efficient solution that meets your needs.

Here at Bobtot, we take customer care very seriously. Our customers are our first priority, and we are committed to providing the highest quality service. If you have any questions or concerns, please don't hesitate to reach out to us. We will be happy to assist you:

Call or Message: +1 (888) 572-1718

Email: service@bobtot.net

Certification

FCC Warning

This device complies with part 15 of the FCC Rules. Operation is subject to the following two conditions:

- (1) This device may not cause harmful interference, and
- (2) this device must accept any interference received, including interference that may cause undesired operation.

Any Changes or modifications not expressly approved by the party responsible for compliance could void the user's authority to operate the equipment.

Note: This equipment has been tested and found to comply with the limits for a Class B digital device, pursuant to part 15 of the FCC Rules. These limits are designed to provide reasonable protection against harmful interference in a residential installation.

This equipment generates uses and can radiate radio frequency energy and, if not installed and used in accordance with the instructions, may cause harmful interference to radio communications. However, there is no guarantee that interference will not occur in a particular installation. If this equipment does cause harmful interference to radio or television reception, which can be determined by turning the equipment off and on, the user is encouraged to try to correct the interference by one or more of the following measures:

- Reorient or relocate the receiving antenna.
- Increase the separation between the equipment and receiver.
- Connect the equipment into an outlet on a circuit different from that to which the receiver is connected.
- Consult the dealer or an experienced radio/TV technician for help.

This equipment complies with FCC radiation exposure limits set forth for an uncontrolled environment.

This equipment should be installed and operated with minimum distance 20cm between the radiator & your body.

bobtot.net

Bobtot